

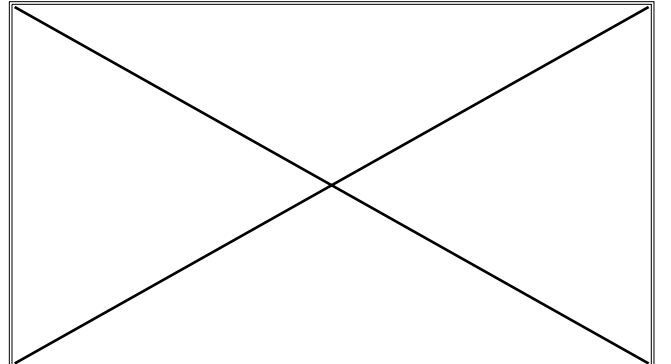

Shot	Panel	Duration
33T	1/1	01:00

Shot	Panel	Duration
34	1/3	01:00

NO PANEL

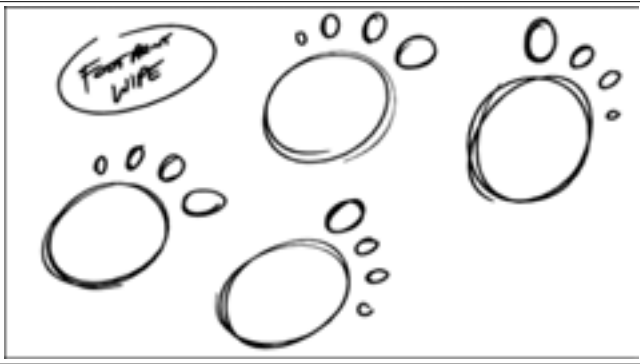

Action Notes:
 FOOTPRINT WIPE

Action Notes:
 FOOTPRINT WIPE IN TO
 CLOSE ON BILLIE RIDING IN WAGON



Shot	Panel	Duration
34	2/3	02:00



Action Notes:
CRANE AND TRK-OUT TO JESS

Shot	Panel	Duration
34	3/3	01:00



Dialogue:
BILLIE
Faster, Jess, faster!

Action Notes:
PIVOT CAMERA CCW
TO OTS JESS ON BILLIE



Shot	Panel	Duration
35_CAM	1/1	01:00



Notes:
 CAMERA MAP - FOR REFERENCE ONLY!
 DO NOT USE FOR VISUAL!!!!

Shot	Panel	Duration
35	1/5	00:16



Action Notes:
 CUT
 WIDER ON JESS AND BILLIE
 PAN CAM WITH GANG

Shot	Panel	Duration
35	2/5	00:16



Action Notes:
 CONT PAN CAM WITH GANG
 JESS LOSES CONTROL OF WAGON



Shot	Panel	Duration
35	3/5	00:16



Dialogue:
 BILLIE
 (cries out)

Action Notes:
 BILLIE AND WAGON GAIN LT
 CONT PAN CAM WITH GANG

Shot	Panel	Duration
35	4/5	00:16



Action Notes:
 STOP PAN CAM AS BILLIE EXITS LT AND JESS SCREECHES TO A STOP CLOSE TO CAM.
 DIAG TRK-IN TO ADJUST ON JESS



Shot	Panel	Duration
35	5/5	01:08



Action Notes:
STOP TRK-IN CLOSE ON JESS

Shot	Panel	Duration
35_1	1/2	01:00



Dialogue:
BILLIE
AAAAAAHHHHHH!!!

Action Notes:
CUT
TO BILLIE IN WAGON RACING OUT OF CONTROL TO STABLE (BARN SIDE)



Shot	Panel	Duration
35_1	2/2	01:00



Dialogue:

BILLIE (CONT'D)
AAAAAAHHHHHH!!!

Shot	Panel	Duration
35_2	1/1	01:12



Dialogue:

BILLIE (CONT'D)
AAAAAAHHHHHH!!!

Action Notes:

CUT
CLOSE ON BILLIE RIDING IN WAGON
CAMERA SHAKE

NO PANEL

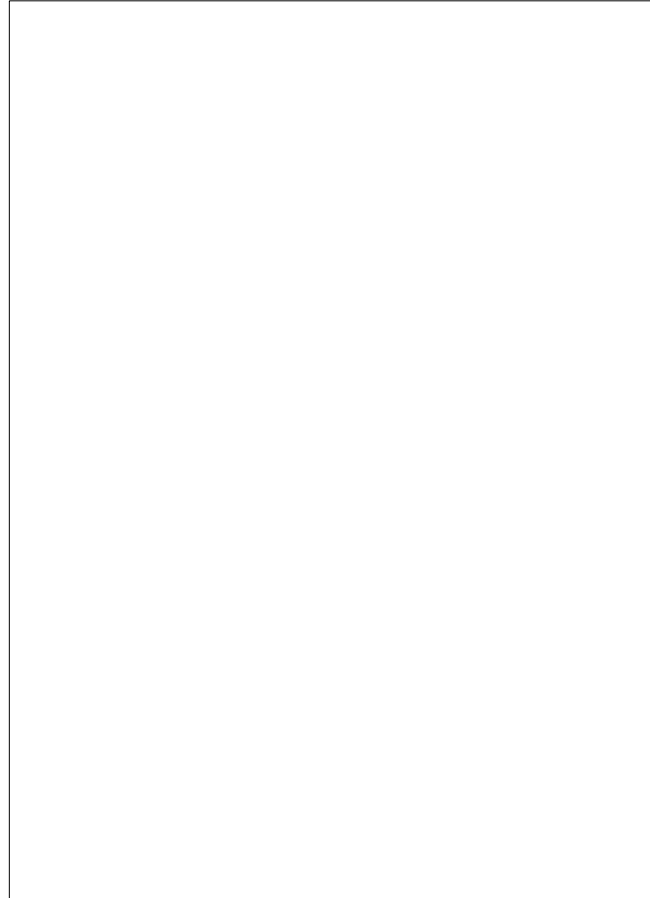
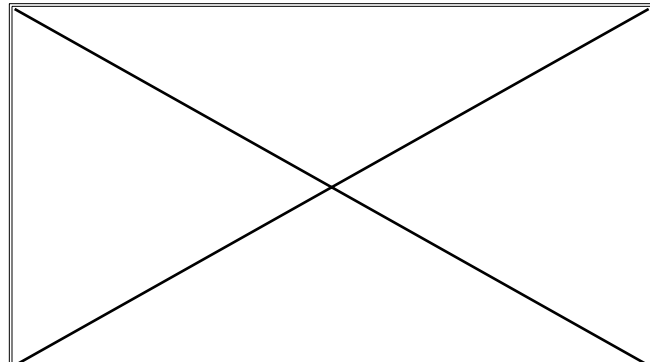



Shot	Panel	Duration
35_3	1/1	01:12

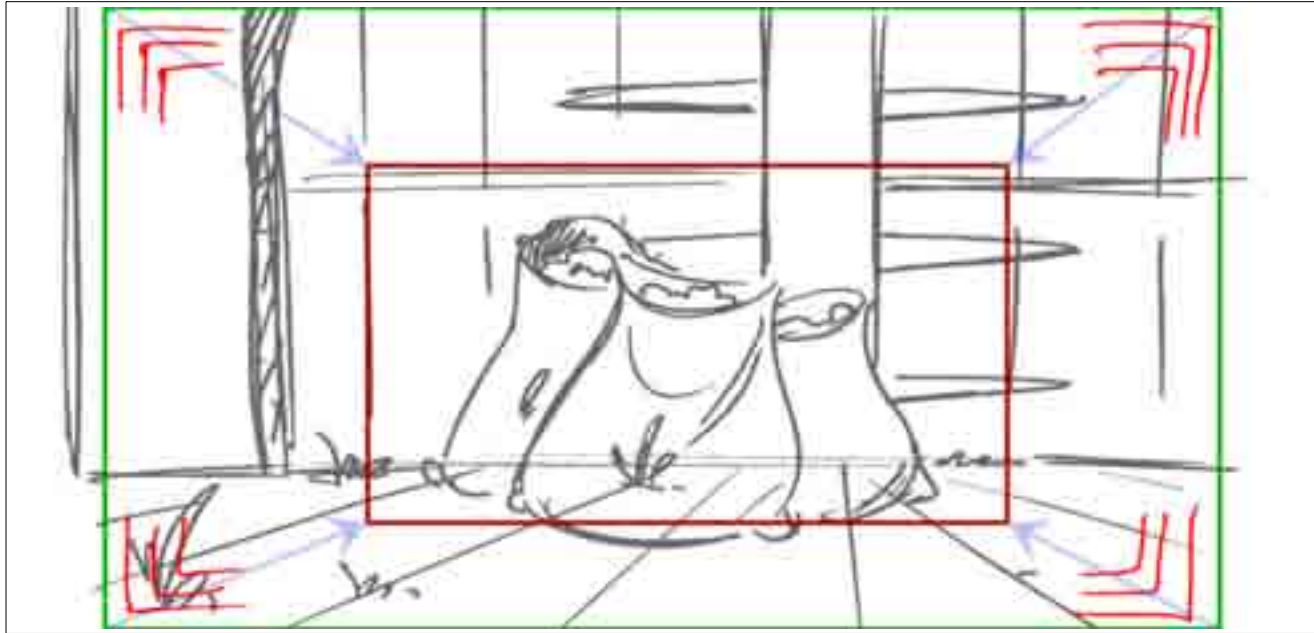

Action Notes:
 CUT
 BILLIE'S POV HEADING TOWARD BAGS OF OATS (TRK-IN)
 CAMERA SHAKE

Shot	Panel	Duration
35_4	1/3	00:12

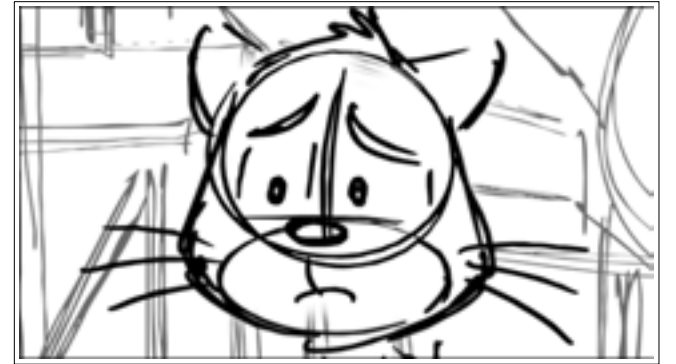

Action Notes:
 CUT
 CLOSE ON JESS



Shot	Panel	Duration
35_4	2/3	01:00

Shot	Panel	Duration
35_4	3/3	01:00

NO PANEL

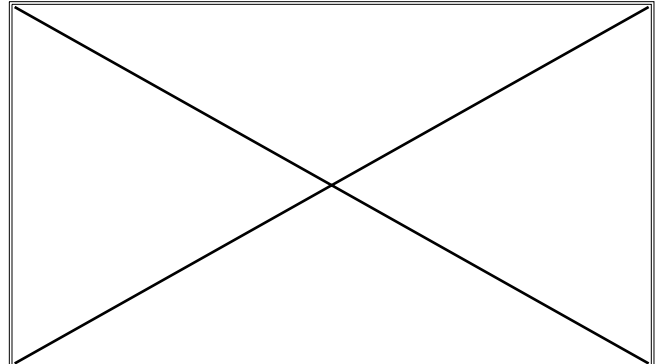

Action Notes:
CAMERA SHAKE AS JESS REACTS



Shot	Panel	Duration
36	1/5	02:12

NO PANEL

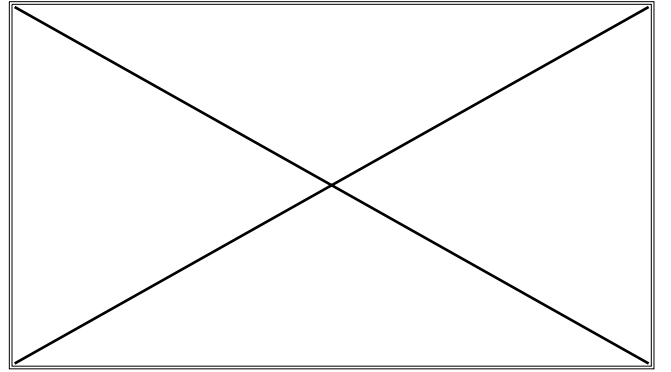

Action Notes:

CUT
CLOSE ON BILLIE ON TOP OF OAT BAG
SLOW TRK-IN

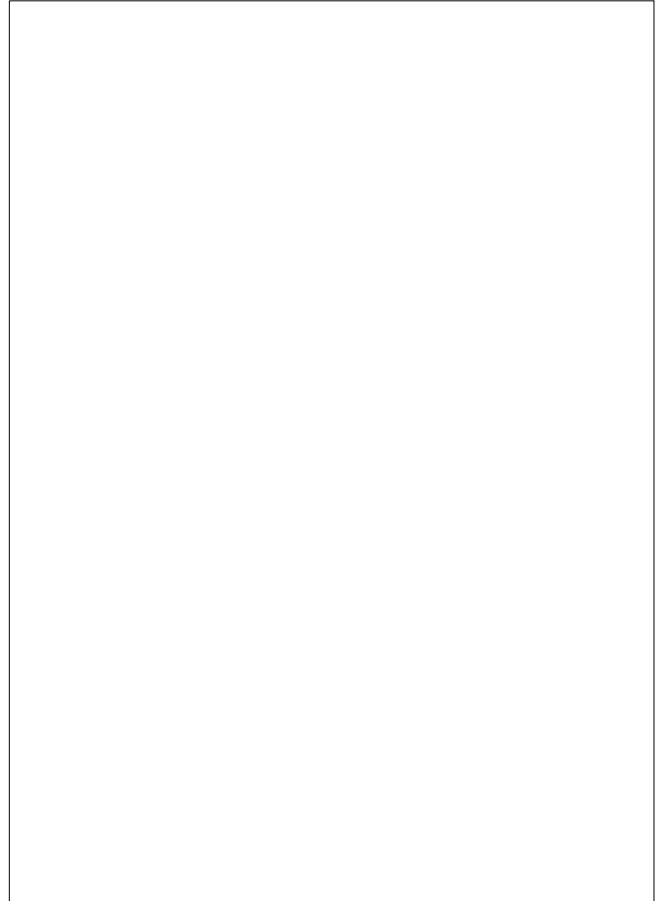



Shot	Panel	Duration
36	2/5	01:16



Dialogue:

JESS

Ooops!

Action Notes:

TRK-OUT

AS JESS RUNS IN

Shot	Panel	Duration
36	3/5	01:00





Shot	Panel	Duration
36	4/5	01:16

NO PANEL

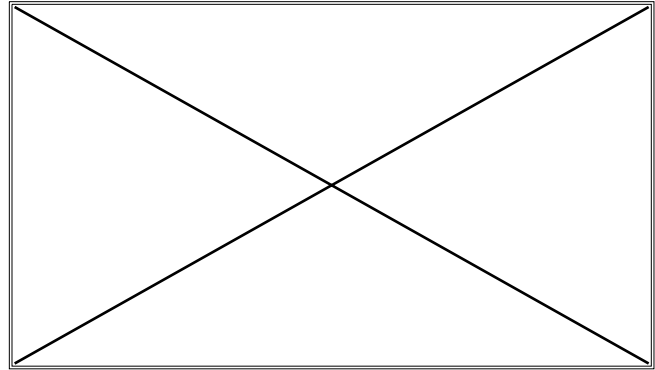

Action Notes:

TRK OUT WIDER

JESS LOOKS DOWN AT OATS AS BILLIE HOPS DOWN

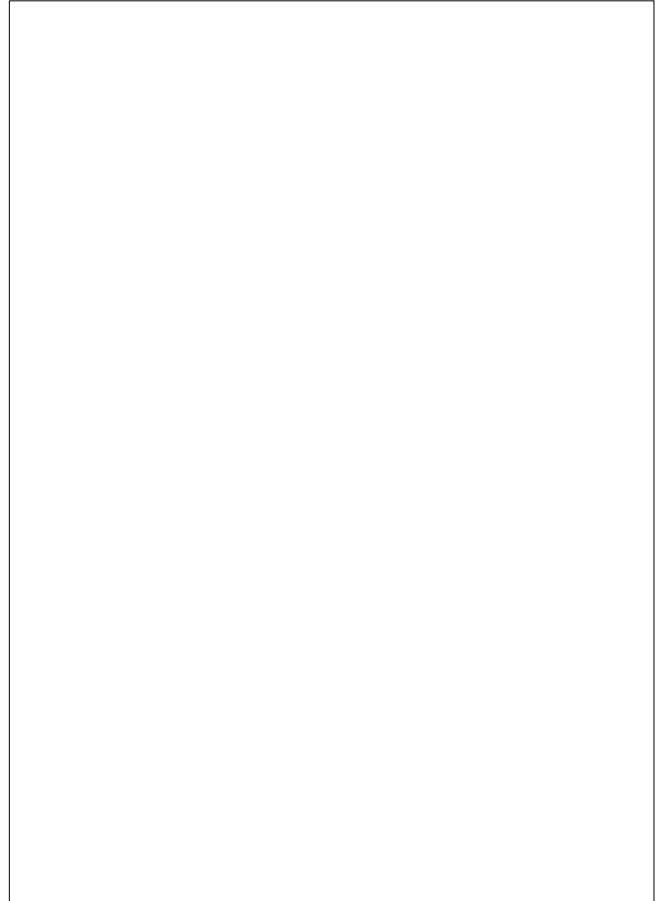



Shot	Panel	Duration
36	5/5	01:08

NO PANEL

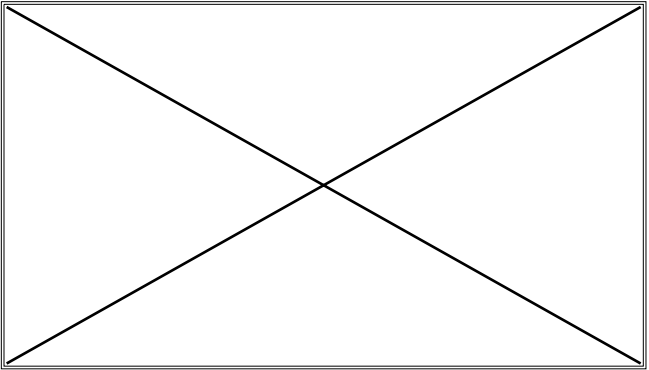

Dialogue:

JESS
What's this?

Action Notes:

JESS SNIFFS AT OATS SPILLED ON GROUND
TRK-IN CLOSER ON JESS AND BILLIE

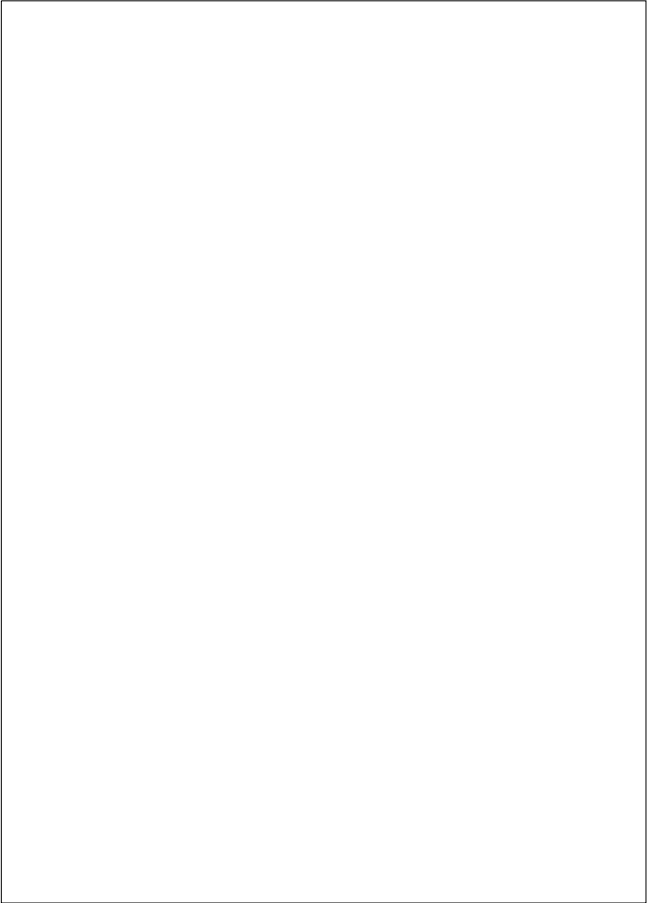



Shot	Panel	Duration
37	1/5	02:12

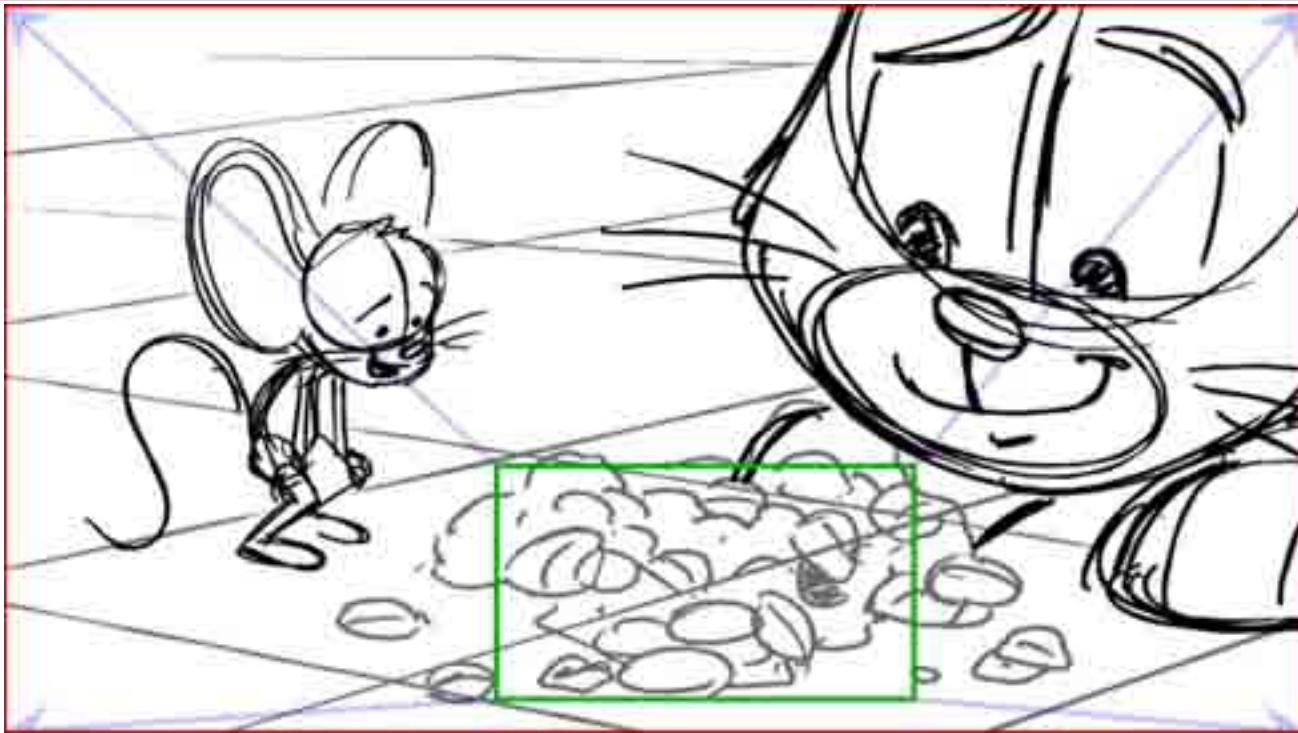

Dialogue:
 BILLIE
 They're oats! Oats are Willow's favourite.

Action Notes:
 CUT CLOSE ON OATS
 TRK-OUT TO INCLUDE BILLIE AND JESS

Shot	Panel	Duration
37	2/5	01:12



Dialogue:
 BILLIE
 She loves them 'cause they're so chewy.



Shot	Panel	Duration
37	3/5	01:12



Dialogue:

JESS
We don?t need chewy food, we need crunchy food!

Shot	Panel	Duration
37	4/5	01:00



Action Notes:

JESS SETTLES UP

Shot	Panel	Duration
37	5/5	01:00

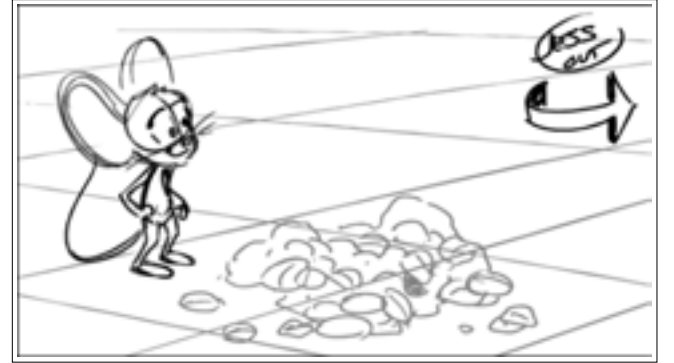

Action Notes:

JESS SETTLES UP



Shot	Panel	Duration
38_CAM	1/1	01:00



Notes:
 CAMERA MAP - FOR REFERENCE ONLY!
 DO NOT USE FOR VISUAL!!!!

Shot	Panel	Duration
38	1/3	00:16

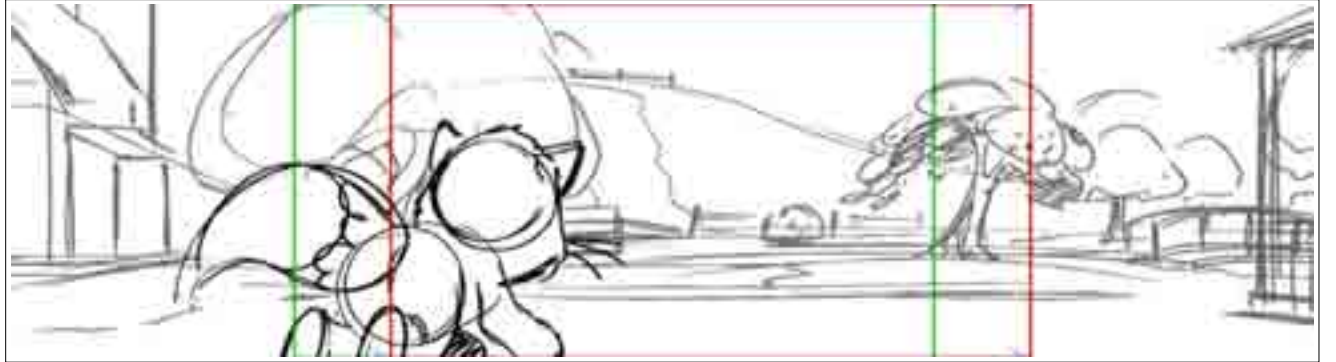

Dialogue:
 JESS
 Look!

Action Notes:
 CUT
 JESS RUNS IN FROM LT
 PAN RT WITH JESS



Shot	Panel	Duration
38	2/3	00:16

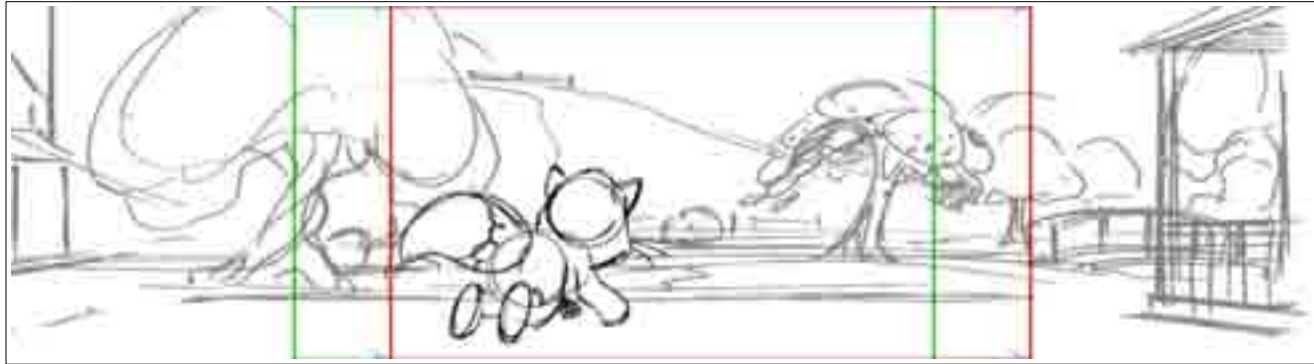

Dialogue:
 JESS (CONT'D)
 There it is!

Action Notes:
 CONT'D PAN WITH JESS

Shot	Panel	Duration
38	3/3	01:00



Dialogue:
 JESS (CONT'D)
 The hazelnut tree!

Action Notes:
 STOP PAN AS JESS STOPS AND TURNS

 WIPE SCENE OUT



Shot	Panel	Duration
38T	1/1	01:00

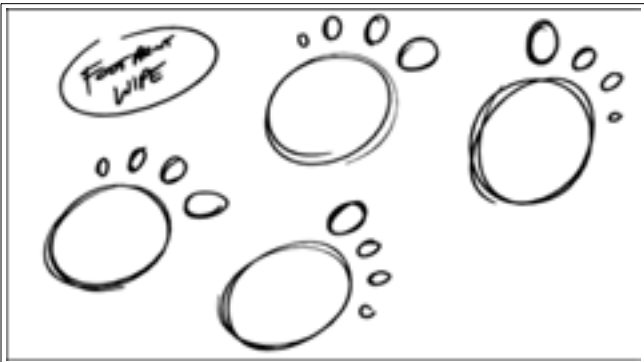

Action Notes:
FOOTPRINT WIPE

Shot	Panel	Duration
38_1_CAM	1/1	01:00



Notes:
CAMERA MAP - FOR REFERENCE ONLY!
DO NOT USE FOR VISUAL!!!!

Shot	Panel	Duration
38_1	1/3	01:00

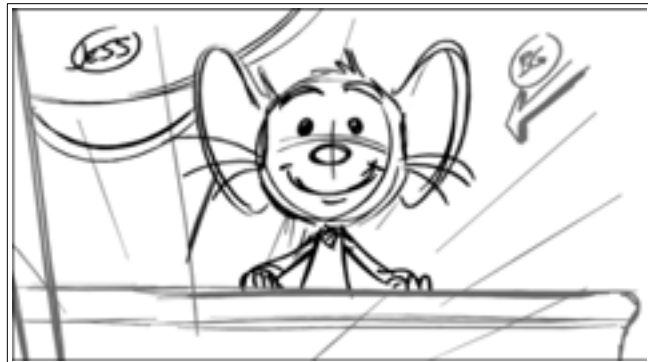

Action Notes:
FOOTPRINT WIPE IN TO
CLOSE ON BILLIE RIDING IN WAGON



Shot	Panel	Duration
38_1	2/3	01:12

Shot	Panel	Duration
38_1	3/3	01:00

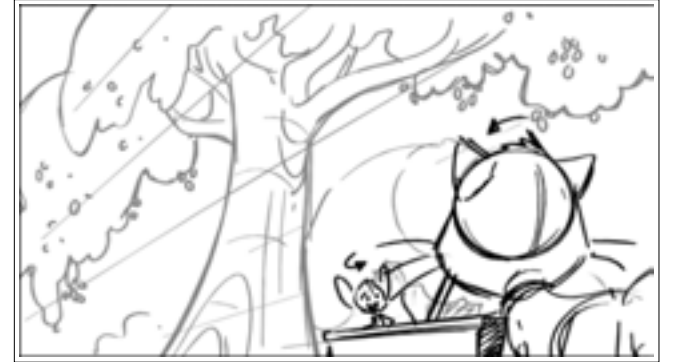
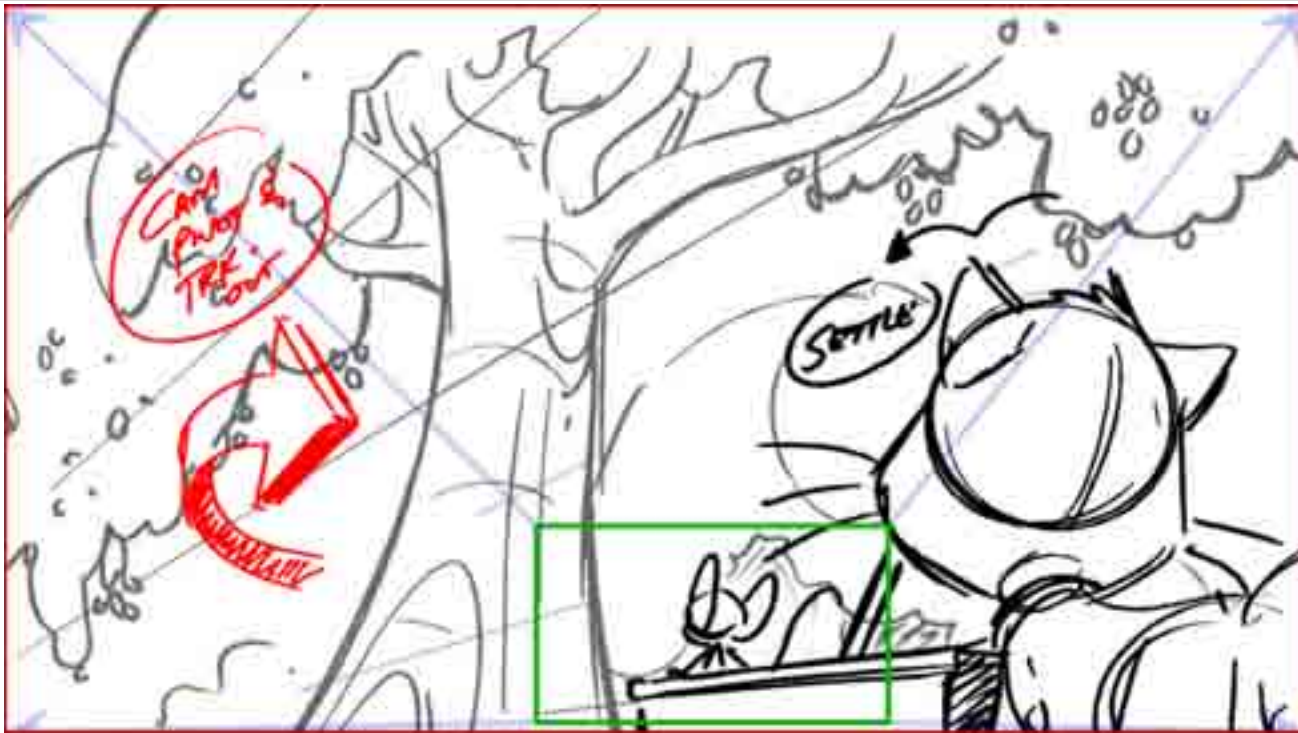

Dialogue:

BILLIE

Can you shake down the nuts
Jess?

Action Notes:

PIVOT CAM CCW AND TRK-OUT
TO OTS JESS AND BILLIE AS THEY SETTLE CLOSE TO TREE



Shot	Panel	Duration
39	1/2	01:00



Dialogue:

BILLIE
Can you shake down the nuts
Jess?

Action Notes:

CUT
AROUND AND WIDE

Shot	Panel	Duration
39	2/2	01:16

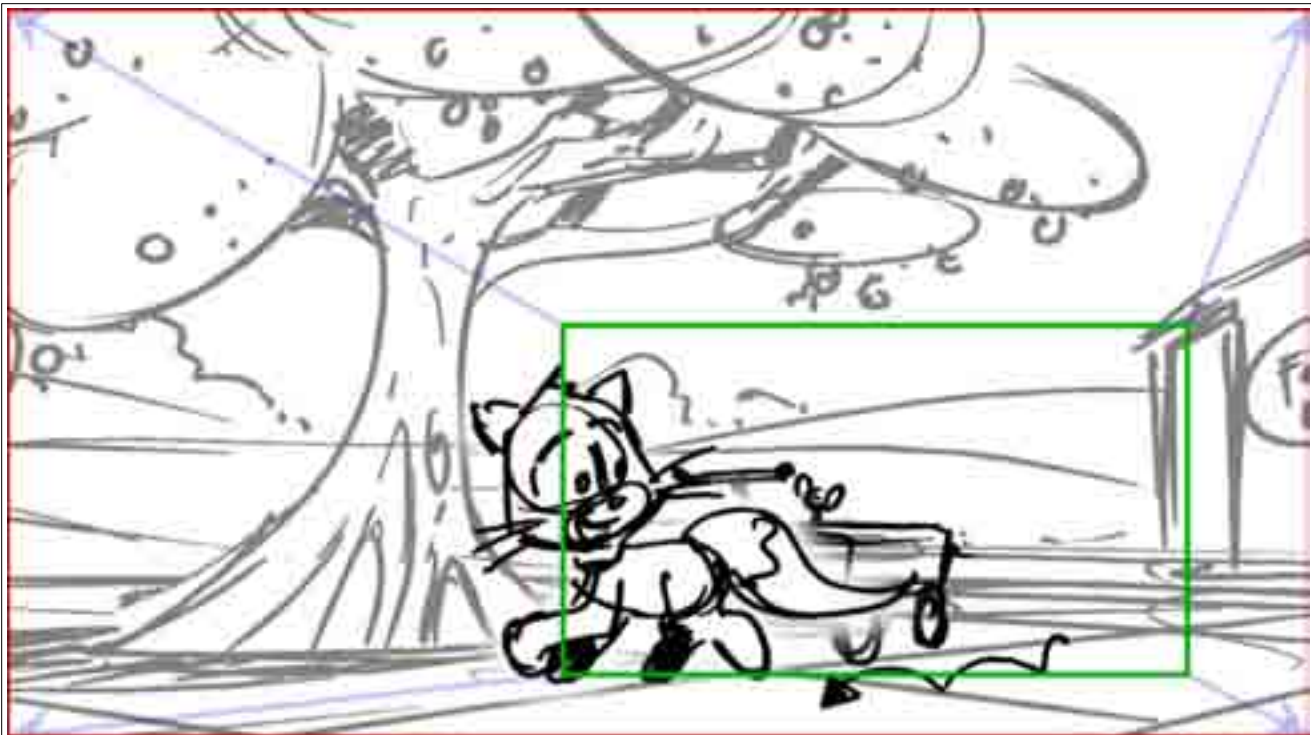

Dialogue:

JESS
'Course!

Action Notes:

TRK-OUT AS JESS APPROACHES TREE



Shot	Panel	Duration
40	1/11	01:00

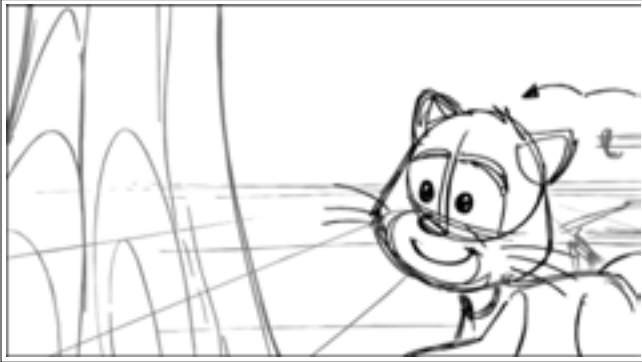

Action Notes:

CUT
CLOSER ON JESS NEARING TREE
TRUNK

Shot	Panel	Duration
40	2/11	01:00



Action Notes:

JESS LEANS AGAINST TREE

Shot	Panel	Duration
40	3/11	01:00



Dialogue:

JESS
(efforts)

Action Notes:

HE SHAKES TREE



Shot	Panel	Duration
40	4/11	01:20



Dialogue:
 JESS
 (efforts)

Action Notes:
 DIAG PAN AND TRK-IN TO BILLIE RUNNING AROUND TRYING TO CATCH NUTS

Shot	Panel	Duration
40	5/11	01:00



Dialogue:
 JESS
 (efforts)



Shot	Panel	Duration
40	6/11	01:00



Dialogue:

JESS
(efforts)

Action Notes:

BILLIE RUNS TO RT TO CATCH
ANOTHER NUT

Shot	Panel	Duration
40	7/11	01:00

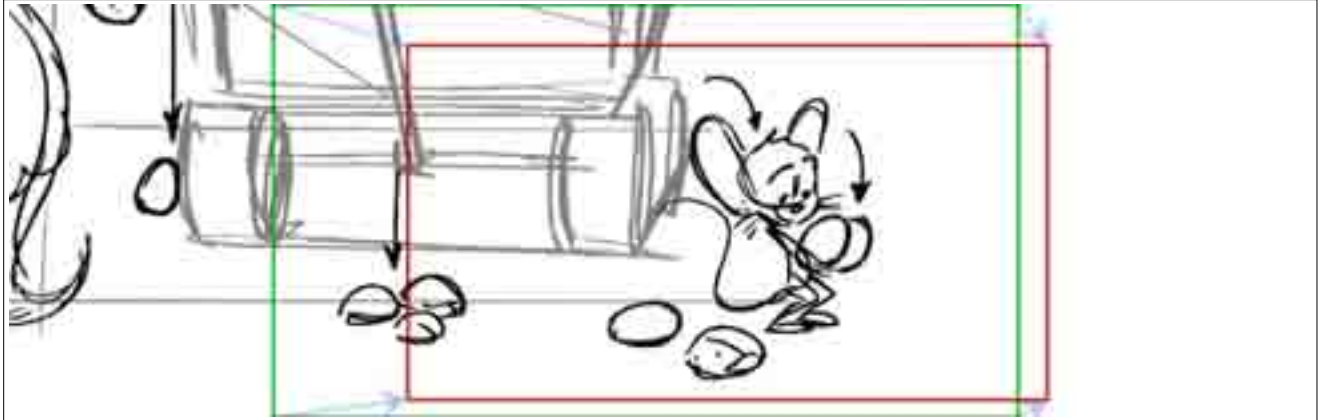

Action Notes:

BILLIE GRABS NUTS



Shot	Panel	Duration
40	8/11	00:12



Action Notes:
BILLIE ANTICS TO THROW NUT

Shot	Panel	Duration
40	9/11	00:20

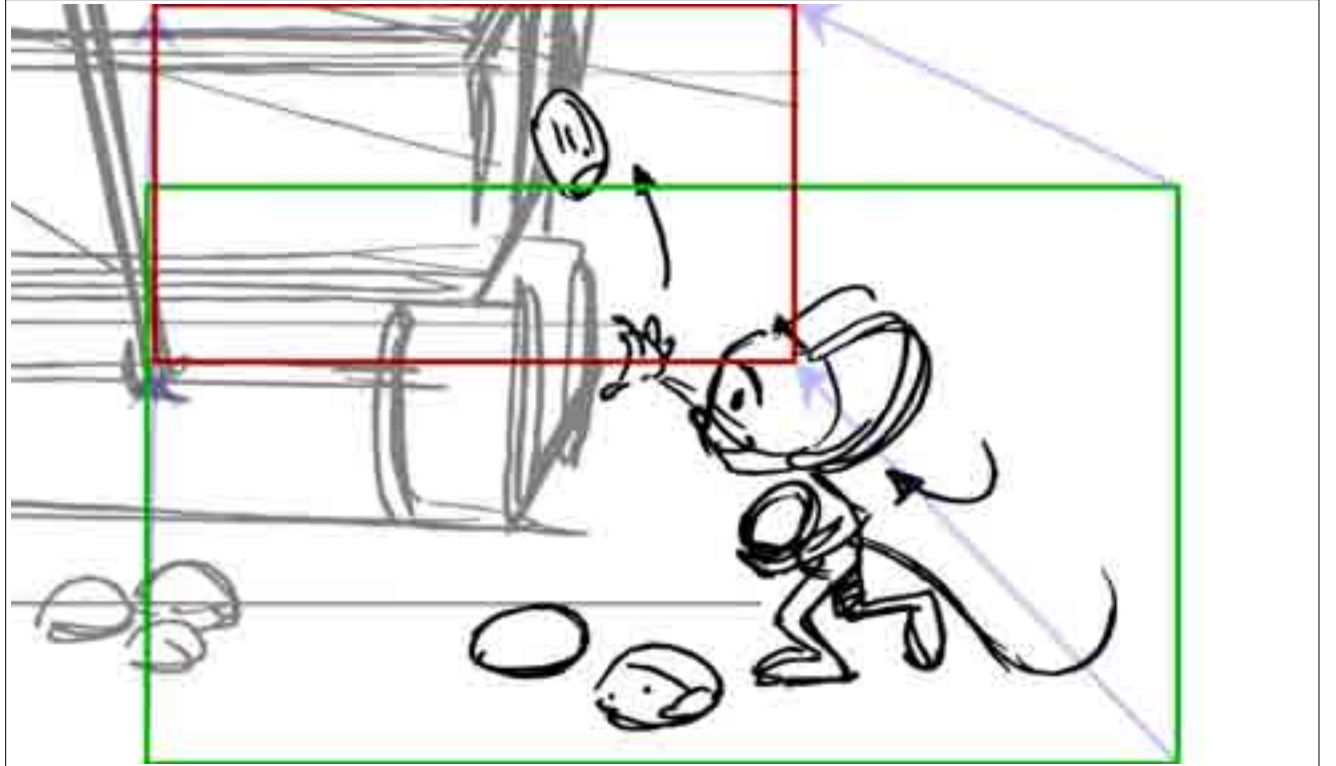

Action Notes:
BILLIE THROWS UP NUTS
CAM TRK-IN AND PAN WITH NUTS



Shot	Panel	Duration
40	10/11	00:18

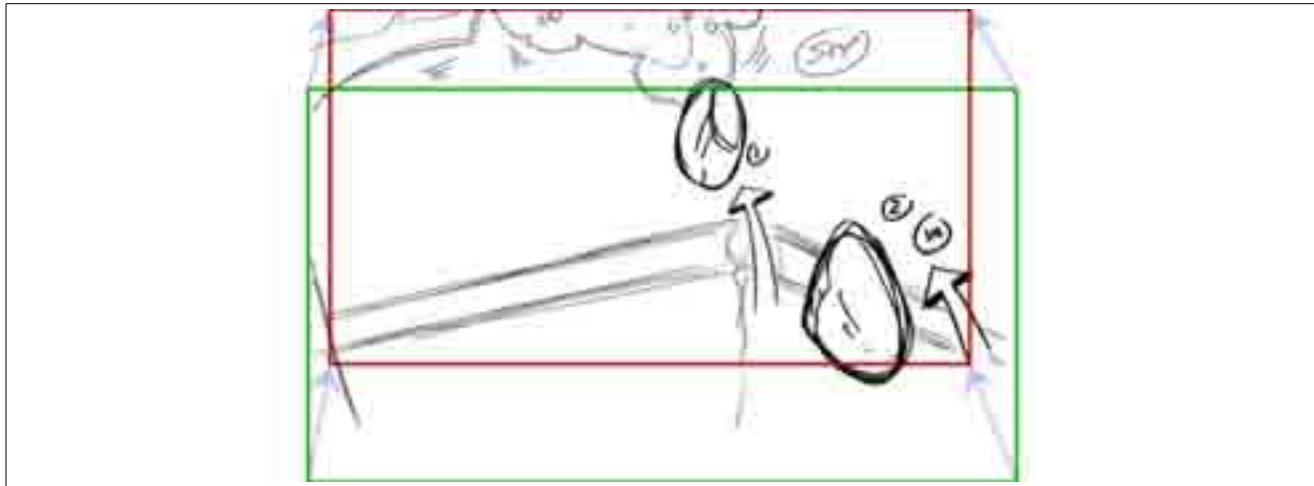

Action Notes:
CAM FOLLOWS NUTS UP OVER EDGE OF WAGON

Shot	Panel	Duration
40	11/11	01:00

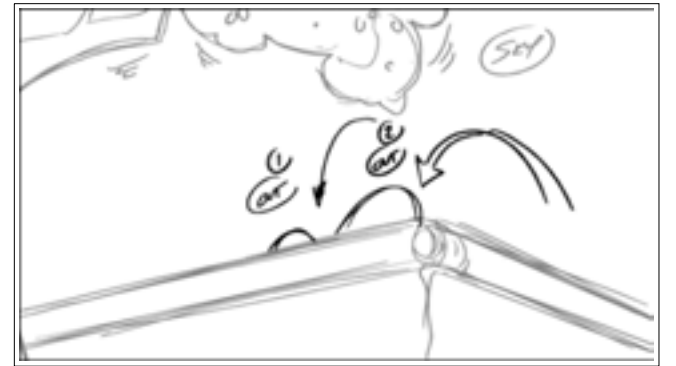

Action Notes:
NUTS FALL INTO WAGON



Shot	Panel	Duration
41	1/1	01:00

Shot	Panel	Duration
42	1/1	02:00

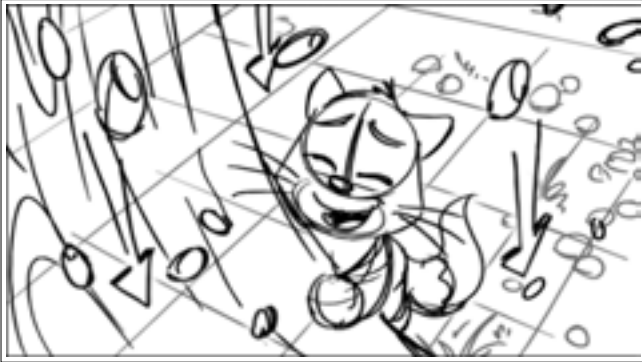

Dialogue:
 JESS
 (efforts)

Action Notes:
 CUT
 TO NUTS FALLING OFF TREE
 TRK-OUT

Action Notes:
 CUT
 TO JESS SHAKING TREE



Shot	Panel	Duration
43	1/2	01:00

Shot	Panel	Duration
43	2/2	01:00

NO PANEL

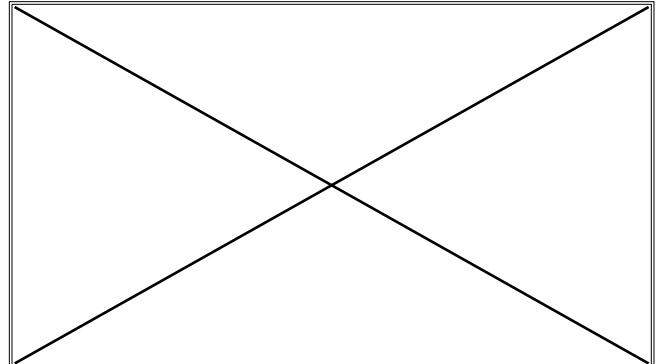
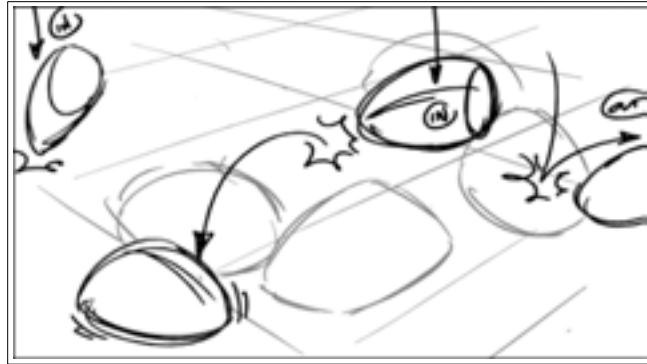
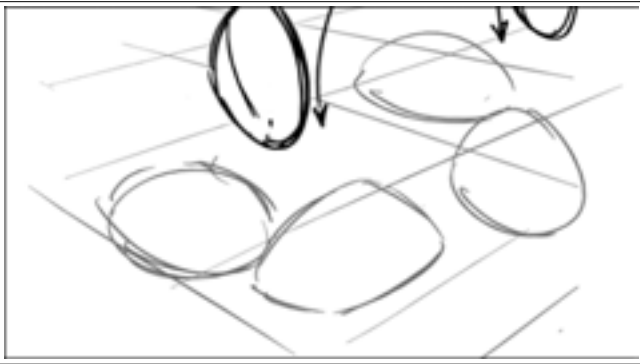

Action Notes:
 CUT
 CLOSE ON NUTS FALLING INTO WAGON



Shot	Panel	Duration
44	1/1	02:12

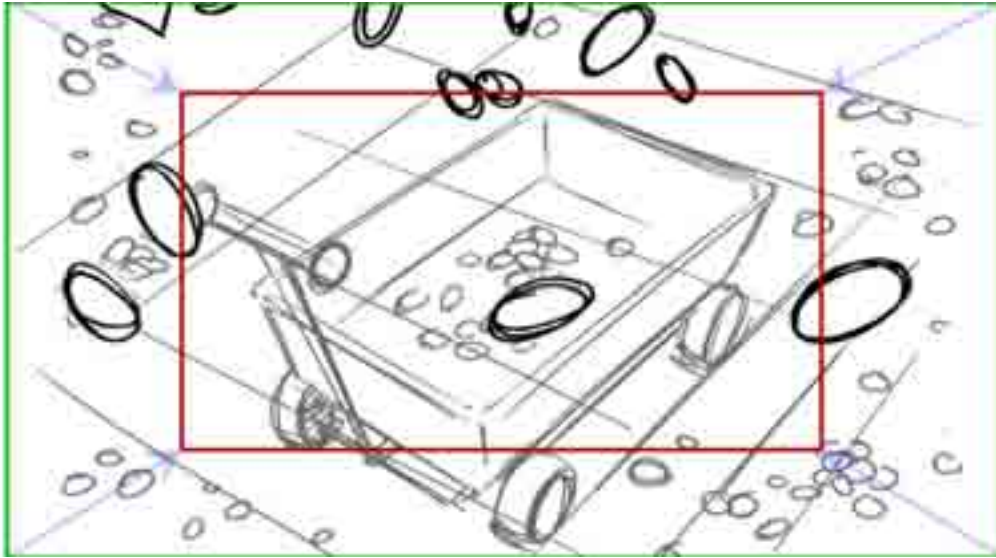

Action Notes:
 CUT
 WIDER ON WAGON AS NUTS FALL IN

Shot	Panel	Duration
45	1/2	01:00



Action Notes:
 CUT
 TO BILLIE RUNNING IN FROM LT
 WITH NUTS



Shot	Panel	Duration
45	2/2	01:00



Action Notes:
BILLIE RUNS OUT RT

Shot	Panel	Duration
45_1	1/2	01:00

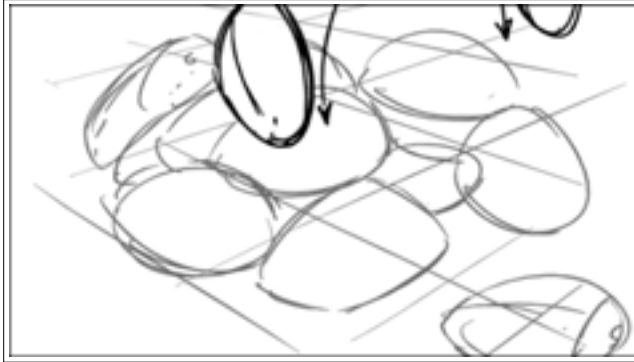

Action Notes:
CUT
CLOSE ON NUTS FALLING

Shot	Panel	Duration
45_1	2/2	01:00

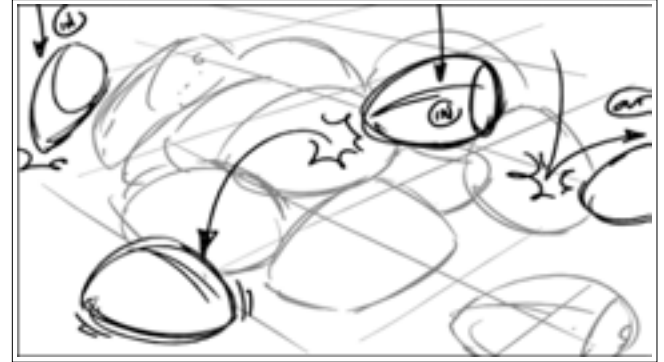



Shot	Panel	Duration
45_2	1/2	01:00

Shot	Panel	Duration
45_2	2/2	01:00

NO PANEL

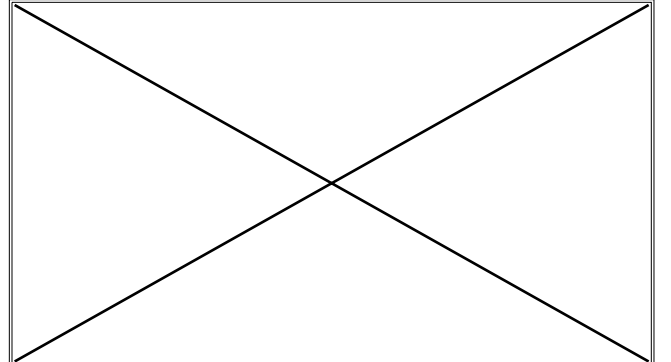

Action Notes:
 CUT
 BACK TO BILLIE

Dialogue:
 BILLIE
 (efforts)



Shot	Panel	Duration
46	1/1	02:16

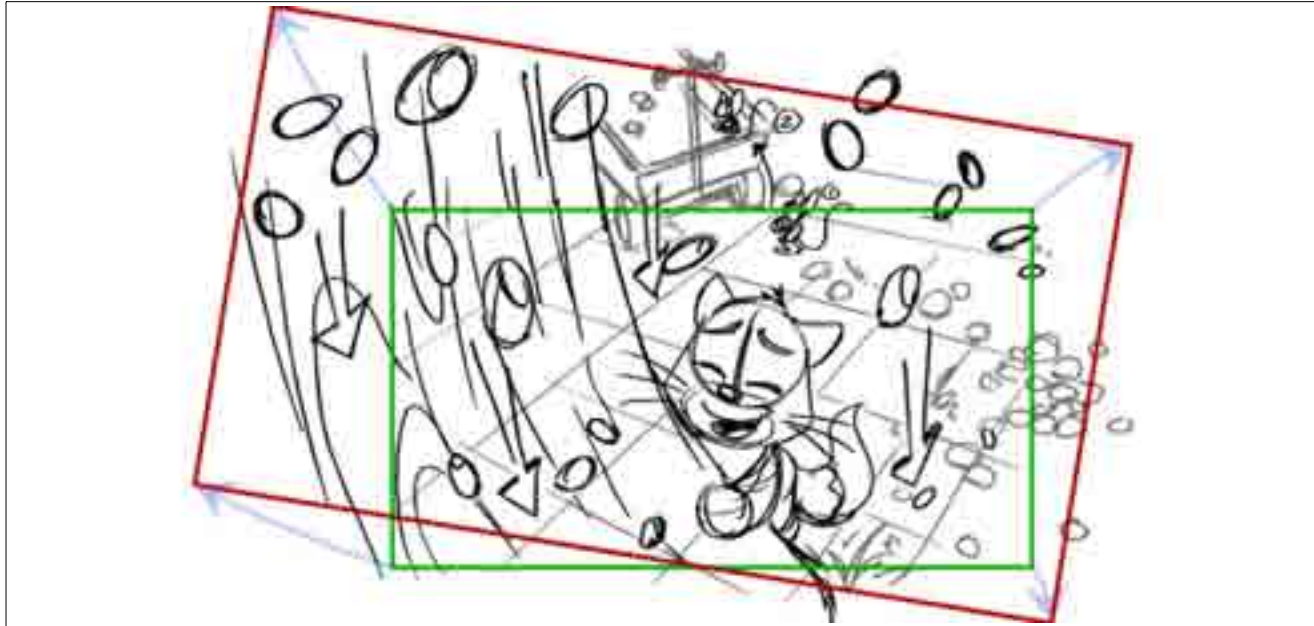

Dialogue:
 JESS
 (efforts)

Action Notes:
 CUT
 BACK TO JESS
 SPIRAL TRK-OUT WIDER
 IN BG, BILLIE (WITH ARMS FULL OF NUTS) JUMPS UP ONTO WAGON

Shot	Panel	Duration
48	1/7	01:00

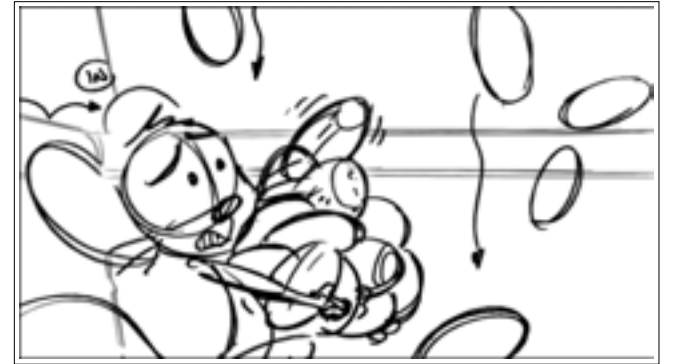

Dialogue:
 BILLIE
 (efforts)

Action Notes:
 CUT
 BACK TO BILLIE



Shot	Panel	Duration
48	2/7	01:00

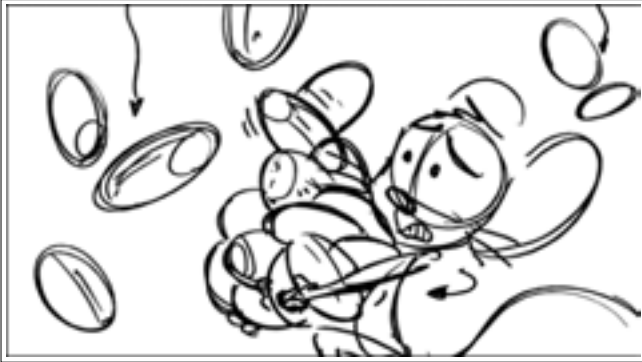

Dialogue:

BILLIE
(efforts)

Shot	Panel	Duration
48	3/7	01:00



Action Notes:

BILLIE GETS PILED OVER IN NUTS

Shot	Panel	Duration
48	4/7	01:00

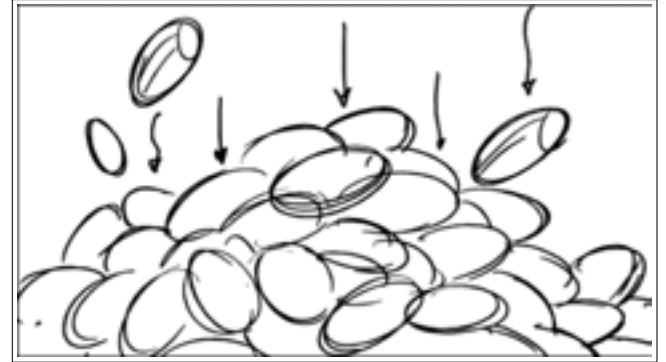

Action Notes:

THEY COVER BILLIE'S HEAD



Shot	Panel	Duration
48	5/7	01:00

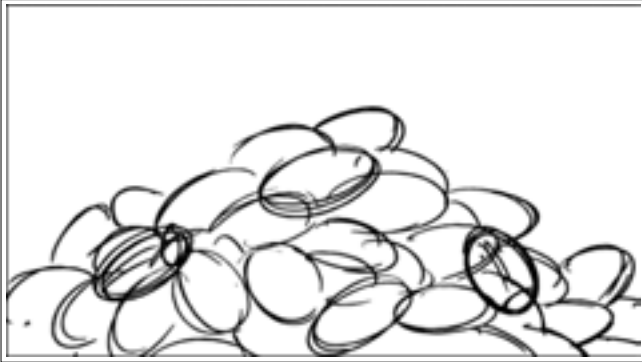

Shot	Panel	Duration
48	6/7	01:00



Action Notes:
 BILLIE'S HEAD POPS UP
 TRK UP WITH BILLIE

Shot	Panel	Duration
48	7/7	01:00



Dialogue:
 BILLIE
 There! That's enough Jess.



Shot	Panel	Duration
49	1/4	01:00



Action Notes:

CUT
WIDER AS JESS SETTLES BY WAGON
AND BILLIE

Shot	Panel	Duration
49	2/4	01:00

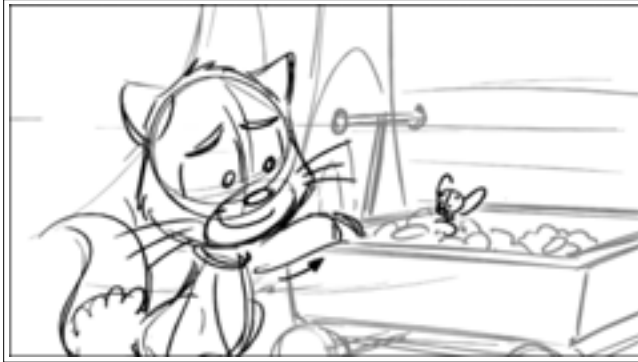

Action Notes:

JESS GRABS A NUT

Shot	Panel	Duration
49	3/4	01:00

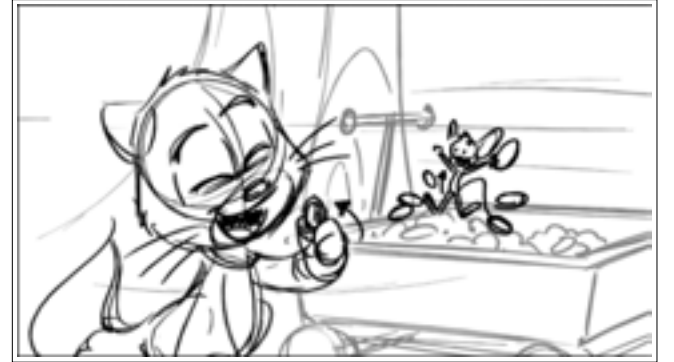

Dialogue:

BILLIE
Wait!

Action Notes:

JESS ANTICS TO EAT NUT AS BILLIE
JUMPS UP



Shot	Panel	Duration
49	4/4	01:08

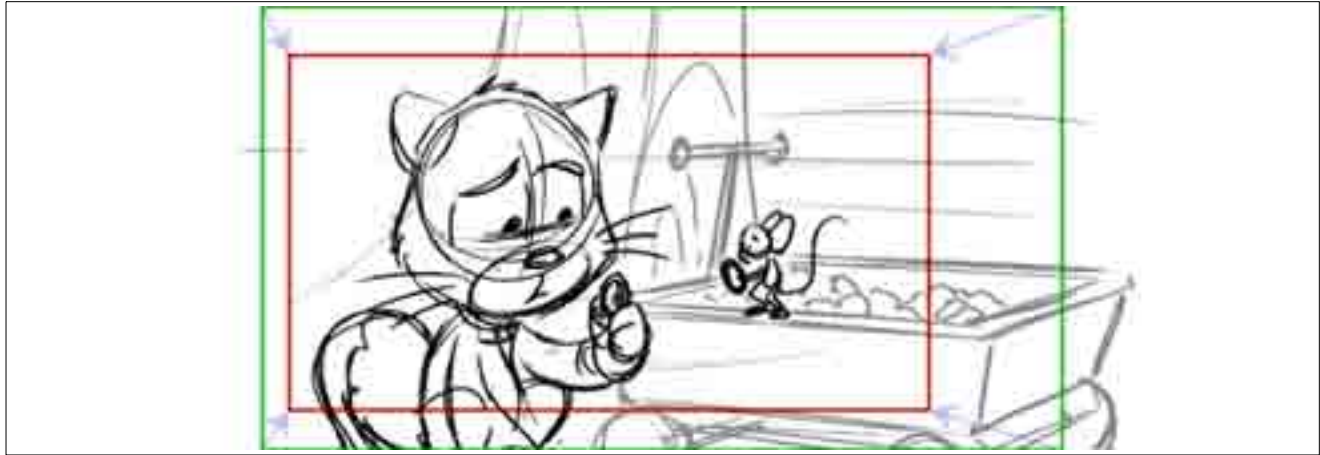

Dialogue:
 BILLIE
 You have to take the shells off first.

Action Notes:
 TRK-IN

Shot	Panel	Duration
50	1/8	00:16



Action Notes:
 CUT
 CLOSER ON BILLIE ANTICS WITH NUT UP



Shot	Panel	Duration
50	2/8	00:20

NO PANEL

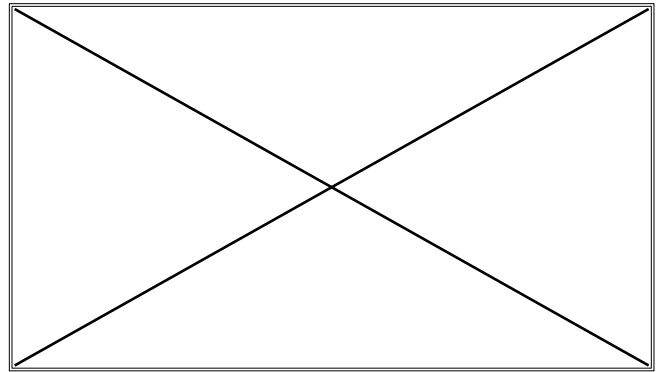
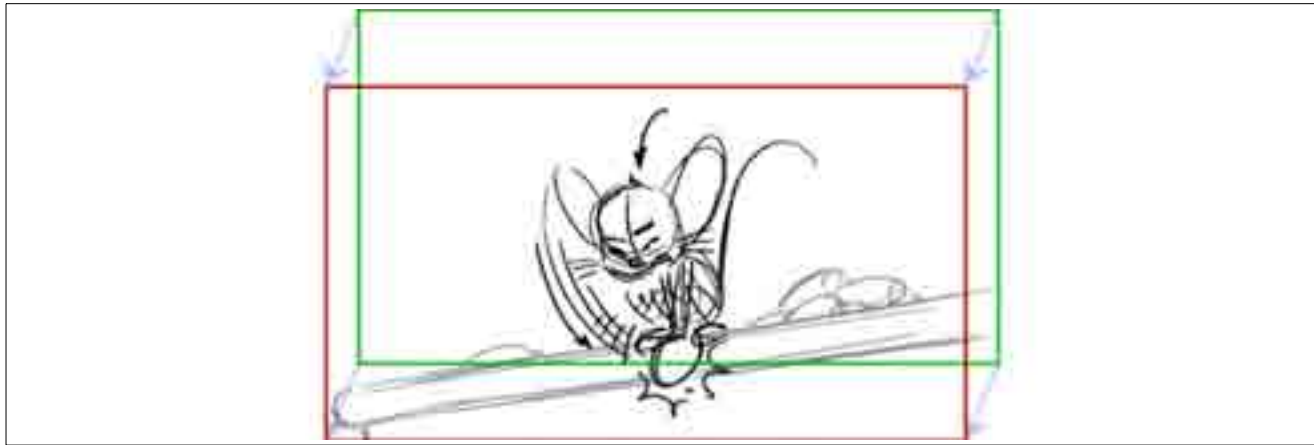

Action Notes:

BILLIE SMASHES NUT ON SIDE OF WAGON
TRK-DOWN

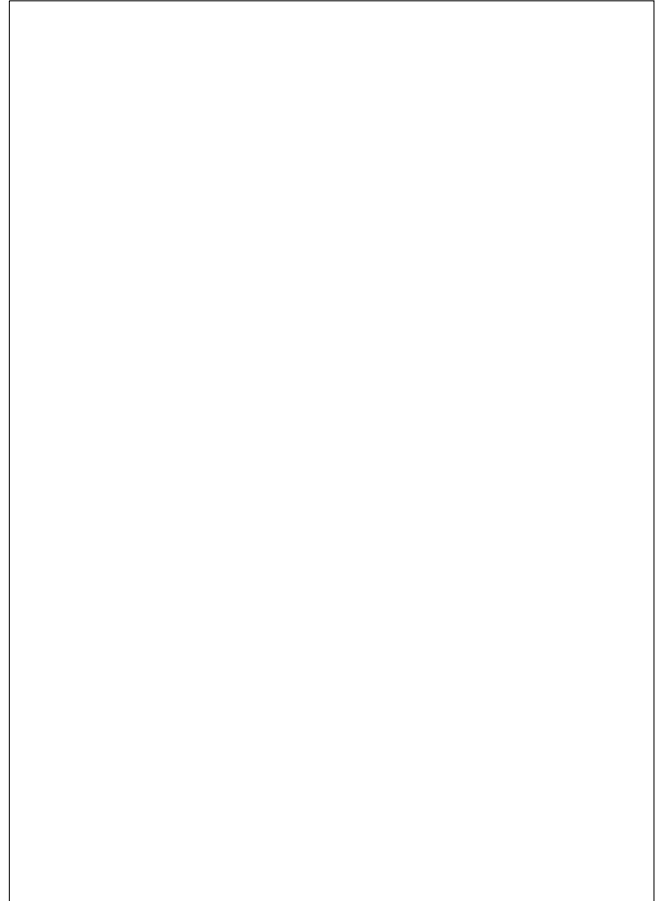



Shot	Panel	Duration
50	3/8	00:20

NO PANEL

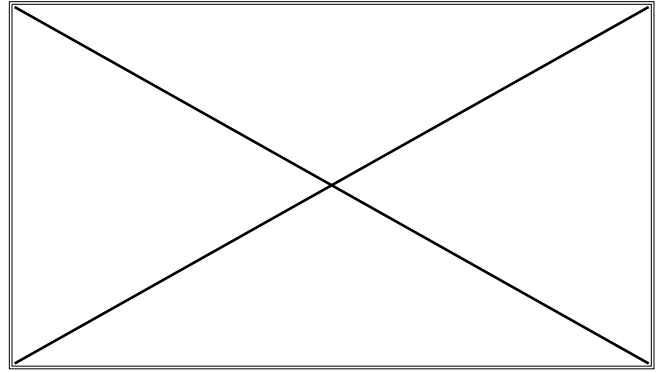

Action Notes:
TRK-UP

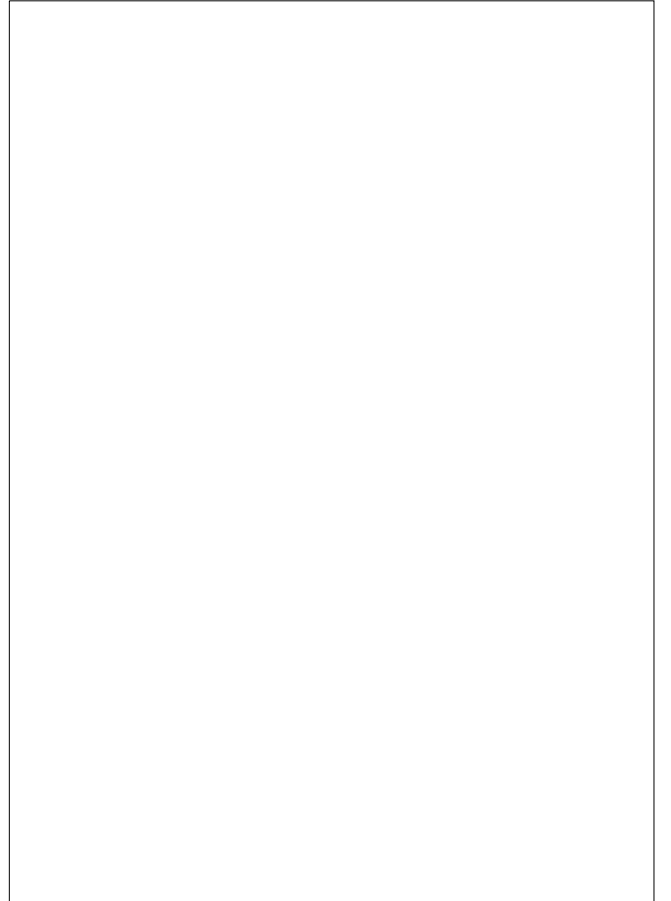



Shot	Panel	Duration
50	4/8	00:20

NO PANEL

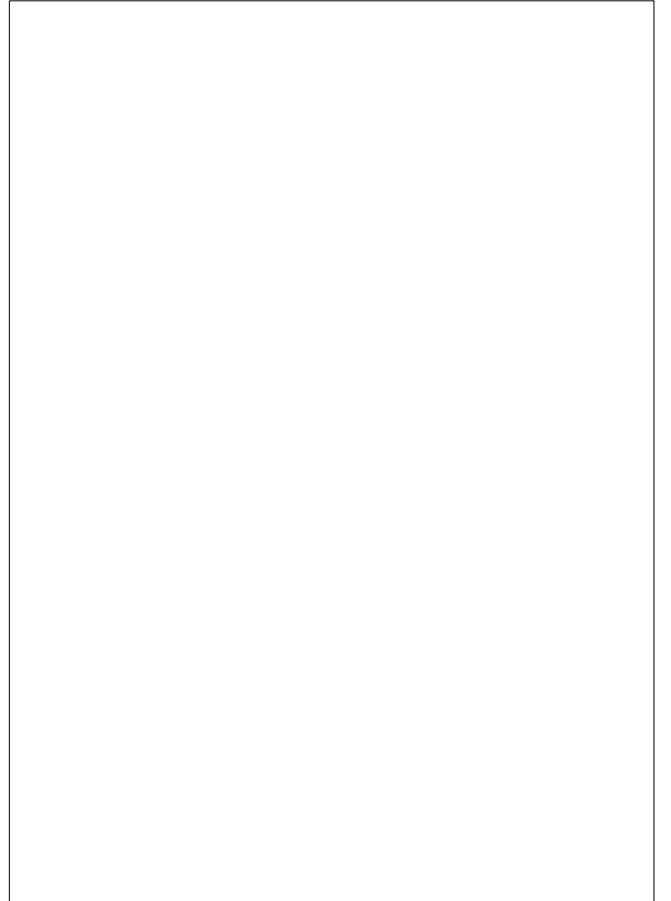
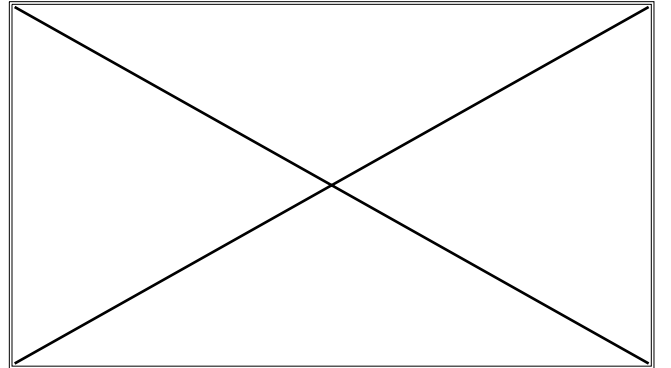
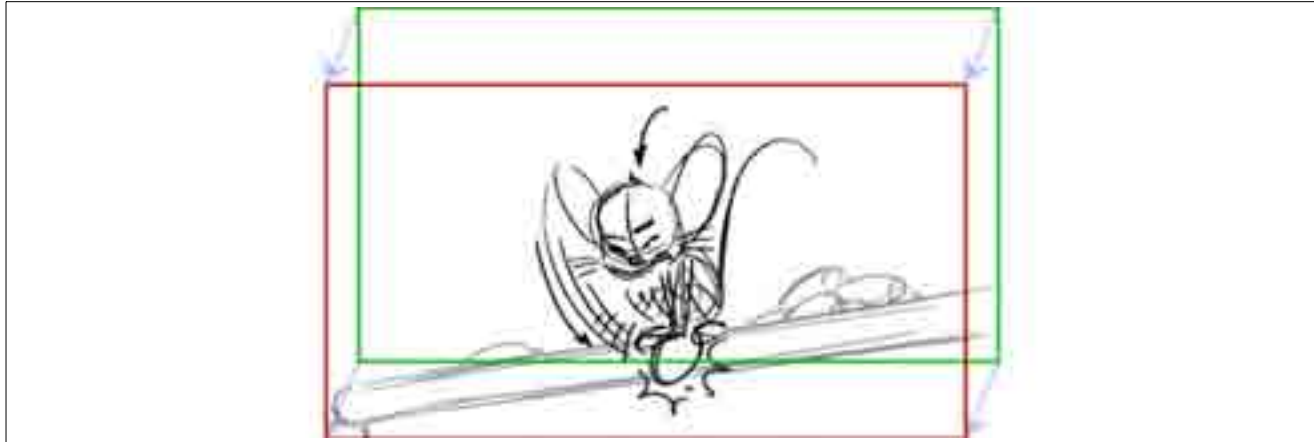



Shot	Panel	Duration
50	5/8	00:20

NO PANEL

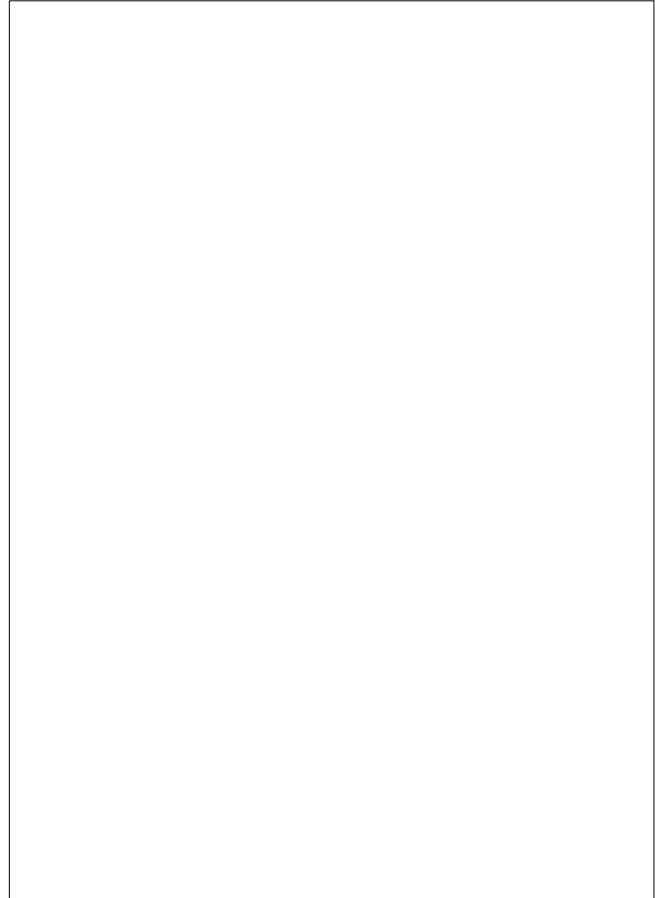
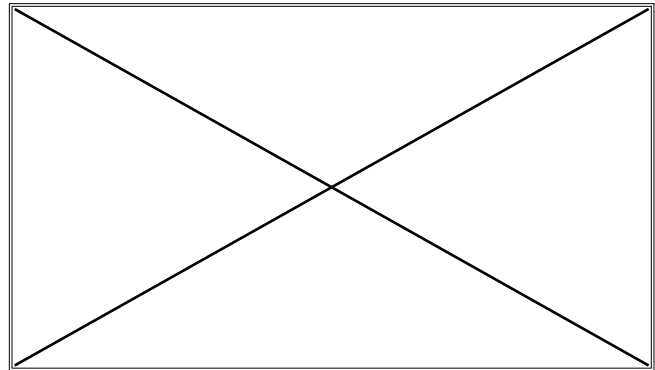
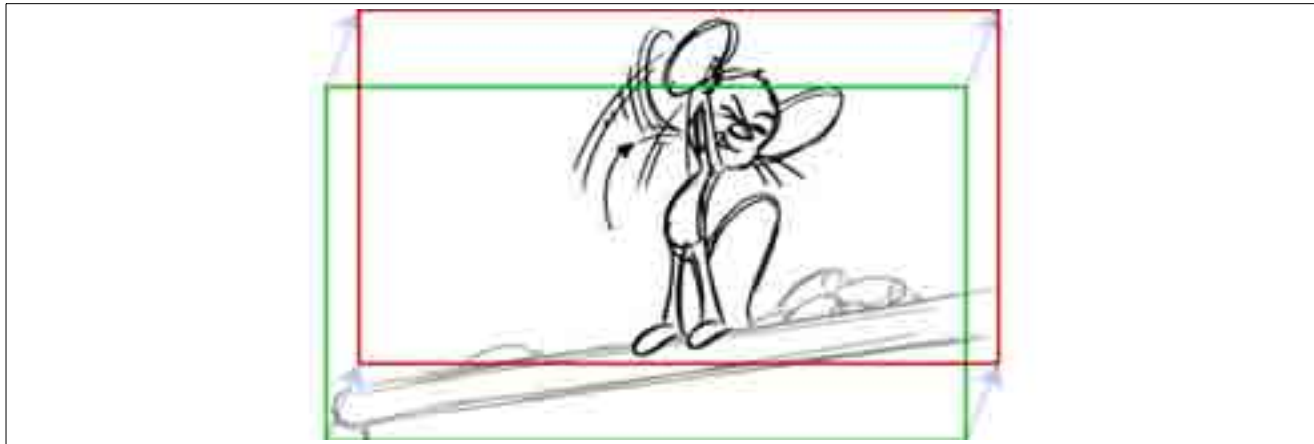



Shot	Panel	Duration
50	6/8	00:20

NO PANEL

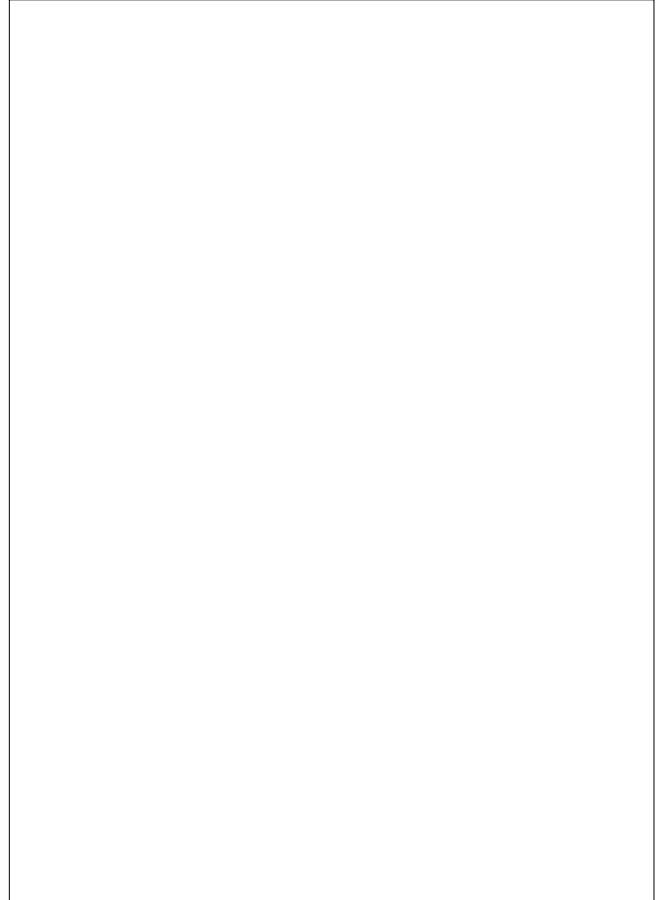
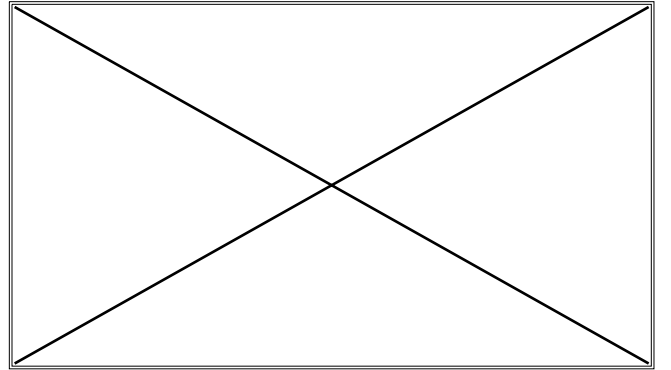
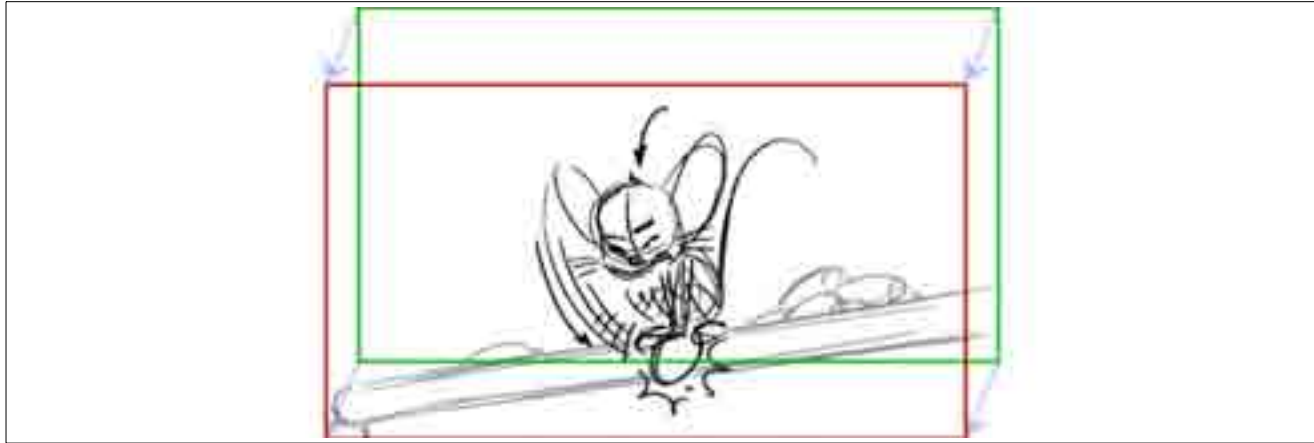



Shot	Panel	Duration
50	7/8	01:00

NO PANEL

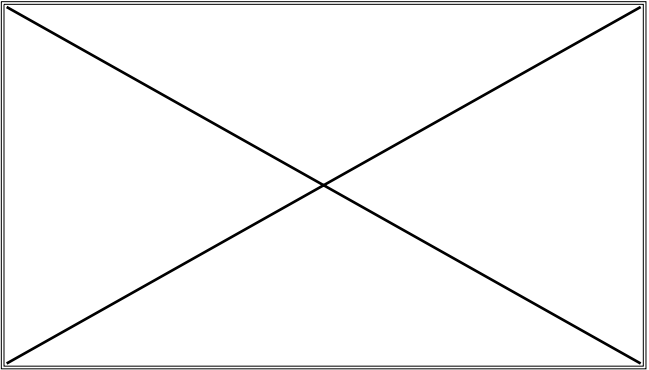

Dialogue:
BILLIE (CONT'D)
See? The crunchy bit's inside!

Action Notes:
TRK-IN CLOSER AS BILLIE REVEALS OPEN NUT

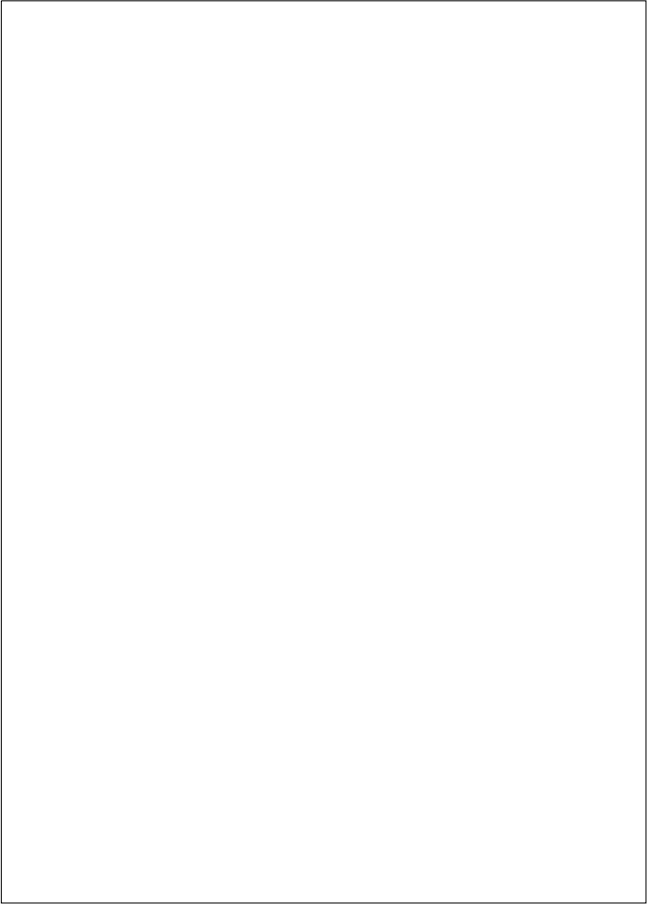



Shot	Panel	Duration
50	8/8	01:00

NO PANEL

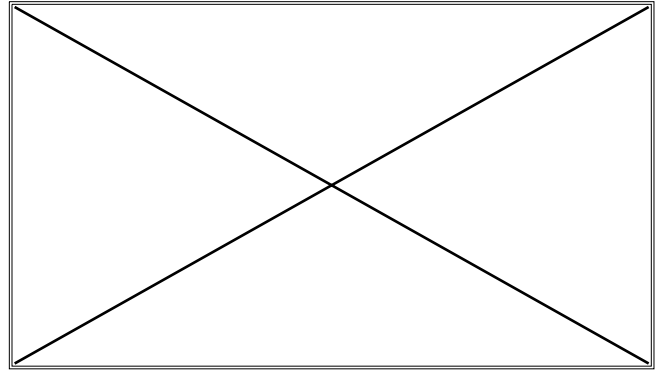

Dialogue:

BILLIE (CONT'D)

I'll crack all the nuts on the way back.

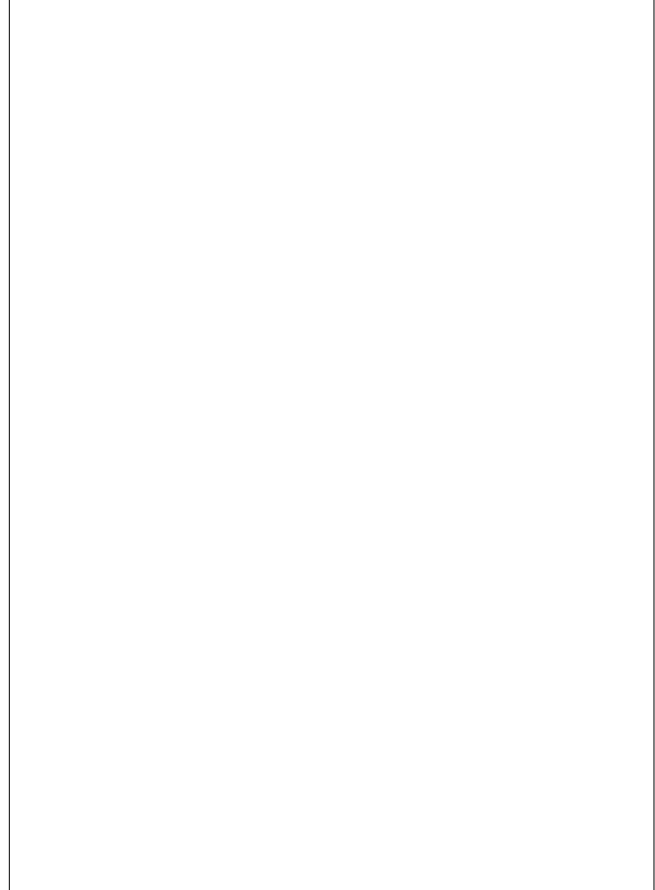



Shot	Panel	Duration
51	1/1	02:16

Shot	Panel	Duration
51T	1/1	01:00

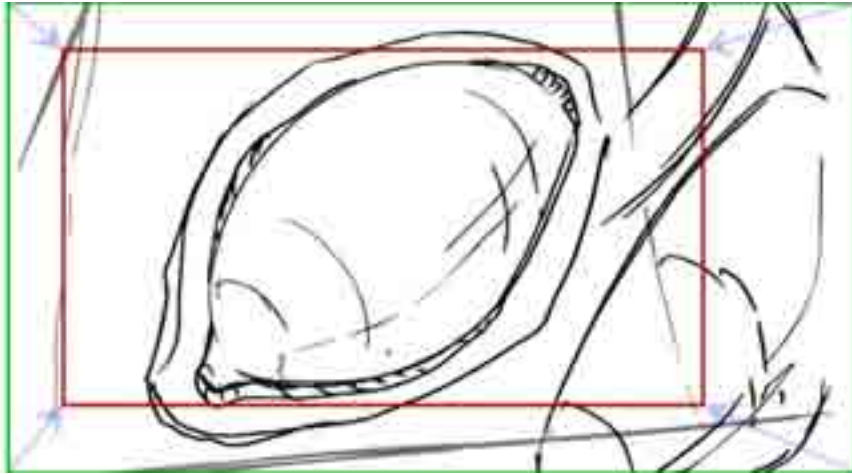

Action Notes:
CUT
CLOSE ON NUT
TRK-IN
MATCH X-DISS OUT

Action Notes:
X-DISS